

# CK

## CHARAKTERISTIKA

- Radiální potrubní ventilátor s kruhovým napojením
- Pro použití v kruhových rozvodech větších délek
- Kompaktní ventilátor s vysokým výkonem a účinností
- Nízká hladina akustického výkonu
- Ventilátor je určen pro dopravu čistého vzduchu bez prachu, mastnot, výparů chemikálií a dalšího znečištění
- Snadná instalace v libovolné poloze
- Pokud je ventilátor připojen na potrubí, může být instalován ve venkovním nebo vlhkém prostředí
- Splňuje ErP

## KONSTRUKCE

- Skříň ventilátoru je vyrobena z pozinkovaného ocelového plechu
- Oběžné kolo s dozadu zahnutými lopatkami

## MOTOR

- AC motor
- Napájení 230 V/50 Hz
- Vnější rotor motoru je vybaven bezúdržbovými zapouzdřenými kuličkovými ložisky
- Integrovaná tepelná ochrana motoru
- Třída izolace motoru F
- IP 44 (ventilátor), IP 54 (připojovací box)
- Lze regulovat transformátorovým nebo elektronickým regulátorem otáček

## INSTALACE

- Snadná a rychlá instalace pomocí montážní konzole v jakékoli poloze

## ROZMĚRY

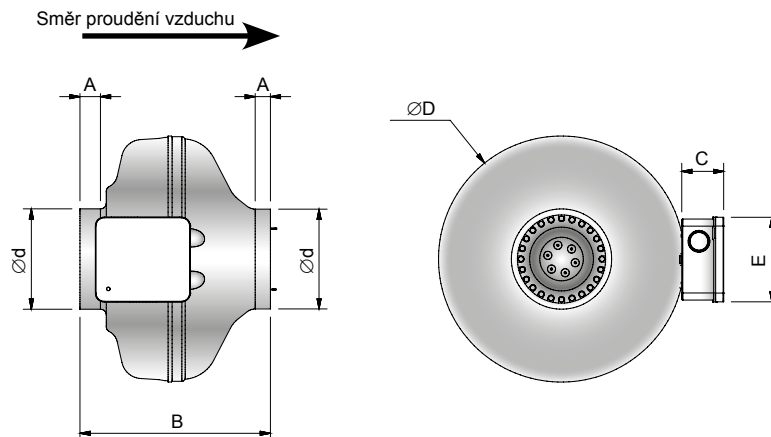

Typ	Rozměry [mm]						
	A	A1	B	C	ØD	Ød	E
CK100	26	26	188	41	243	99	83
CK125	27	27	188	41	243	124	83
CK150B	30	32	191	41	271	149	83
CK150C	30	32	228	41	345	149	83
CK160B	30	32	195	41	271	159	83
CK160C	30	32	226	41	345	159	83
CK200	33	35	228	41	345	199	83
CK250	33	35	228	41	345	249	83
CK315	32	40	257	41	402	314	83

## HLUK

CK100A	Tot	63 Hz	125 Hz	250 Hz	500 Hz	1 kHz	2 kHz	4 kHz	8 kHz
Od sání Lw dB(A)	70	47	59	67	65	62	57	49	42
Od výfuku Lw dB(A)	69	44	60	64	63	62	58	50	42
Do prostoru Lw dB(A)	47	34	22	37	37	42	39	40	34
Do prostoru Lp dB(A)	41	28	16	32	31	36	33	35	28

CK100C	Tot	63 Hz	125 Hz	250 Hz	500 Hz	1 kHz	2 kHz	4 kHz	8 kHz
Od sání Lw dB(A)	71	49	61	66	65	65	59	52	46
Od výfuku Lw dB(A)	71	48	64	66	64	64	60	54	47
Do prostoru Lw dB(A)	50	33	24	40	40	45	42	44	38
Do prostoru Lp dB(A)	44	27	18	34	34	39	37	38	33

CK125A	Tot	63 Hz	125 Hz	250 Hz	500 Hz	1 kHz	2 kHz	4 kHz	8 kHz
Od sání Lw dB(A)	70	46	54	67	65	61	55	49	42
Od výfuku Lw dB(A)	70	45	54	67	64	60	55	50	42
Do prostoru Lw dB(A)	47	34	22	41	67	41	40	42	34
Do prostoru Lp dB(A)	42	28	16	35	31	35	34	36	28

CK125C	Tot	63 Hz	125 Hz	250 Hz	500 Hz	1 kHz	2 kHz	4 kHz	8 kHz
Od sání Lw dB(A)	73	52	57	68	67	66	60	56	49
Od výfuku Lw dB(A)	71	46	58	64	67	65	61	57	50
Do prostoru Lw dB(A)	51	33	24	42	40	44	43	46	39
Do prostoru Lp dB(A)	45	28	18	37	35	39	38	40	33

\* Hlukové údaje měřeny v nedefinovaném prostoru ve vzdálenosti 3 m, pro statický tlak 200 Pa

\*\* Lp: hladina akustického tlaku dB(A) ve vzdálenosti 3 m

\*\*\* Lw: hladina akustického výkonu dB(A)

CK150B	Tot	63 Hz	125 Hz	250 Hz	500 Hz	1 kHz	2 kHz	4 kHz	8 kHz
Od sání Lw dB(A)	70	47	54	64	65	63	58	53	48
Od výfuku Lw dB(A)	69	47	55	61	63	63	59	58	49
Do prostoru Lw dB(A)	49	34	24	39	40	44	42	42	32
Do prostoru Lp dB(A)	43	28	18	33	35	39	36	36	26

CK150C	Tot	63 Hz	125 Hz	250 Hz	500 Hz	1 kHz	2 kHz	4 kHz	8 kHz
Od sání Lw dB(A)	76	48	60	71	71	69	62	62	52
Od výfuku Lw dB(A)	73	49	59	64	66	68	63	62	53
Do prostoru Lw dB(A)	56	33	33	42	49	53	47	48	35
Do prostoru Lp dB(A)	50	28	28	36	43	47	41	42	29

CK160B	Tot	63 Hz	125 Hz	250 Hz	500 Hz	1 kHz	2 kHz	4 kHz	8 kHz
Od sání Lw dB(A)	70	47	54	64	65	63	58	53	48
Od výfuku Lw dB(A)	69	47	55	61	63	63	59	58	49
Do prostoru Lw dB(A)	49	34	24	39	40	44	42	42	32
Do prostoru Lp dB(A)	43	28	18	33	35	39	37	36	26

CK160C	Tot	63 Hz	125 Hz	250 Hz	500 Hz	1 kHz	2 kHz	4 kHz	8 kHz
Od sání Lw dB(A)	76	48	60	71	71	69	62	62	52
Od výfuku Lw dB(A)	73	49	59	64	66	68	63	62	53
Do prostoru Lw dB(A)	56	33	33	42	49	53	47	48	35
Do prostoru Lp dB(A)	50	28	28	36	43	47	41	42	29

CK200A	Tot	63 Hz	125 Hz	250 Hz	500 Hz	1 kHz	2 kHz	4 kHz	8 kHz
Od sání Lw dB(A)	74	50	60	69	70	67	63	60	53
Od výfuku Lw dB(A)	72	49	60	65	66	65	63	62	53
Do prostoru Lw dB(A)	54	32	31	41	46	49	47	47	33
Do prostoru Lp dB(A)	48	27	25	36	40	44	41	41	28

CK200B	Tot	63 Hz	125 Hz	250 Hz	500 Hz	1 kHz	2 kHz	4 kHz	8 kHz
Od sání Lw dB(A)	74	54	62	68	69	67	64	63	58
Od výfuku Lw dB(A)	75	57	61	69	70	67	66	65	60
Do prostoru Lw dB(A)	53	26	34	41	46	48	44	45	36
Do prostoru Lp dB(A)	47	20	28	36	41	43	38	39	30

CK250A	Tot	63 Hz	125 Hz	250 Hz	500 Hz	1 kHz	2 kHz	4 kHz	8 kHz
Od sání Lw dB(A)	75	50	60	67	67	69	68	65	55
Od výfuku Lw dB(A)	76	49	58	69	66	69	71	65	55
Do prostoru Lw dB(A)	55	25	30	34	48	52	47	45	38
Do prostoru Lp dB(A)	49	19	24	28	42	46	42	39	32

CK250B	Tot	63 Hz	125 Hz	250 Hz	500 Hz	1 kHz	2 kHz	4 kHz	8 kHz
Od sání Lw dB(A)	75	53	60	67	67	70	66	64	66
Od výfuku Lw dB(A)	76	56	60	71	66	69	67	65	63
Do prostoru Lw dB(A)	53	29	31	42	46	49	46	43	38
Do prostoru Lp dB(A)	47	23	26	36	40	43	40	38	32

CK315B	Tot	63 Hz	125 Hz	250 Hz	500 Hz	1 kHz	2 kHz	4 kHz	8 kHz
Od sání Lw dB(A)	74	55	59	64	65	66	68	69	63
Od výfuku Lw dB(A)	77	56	59	71	66	70	70	69	64
Do prostoru Lw dB(A)	54	33	38	45	46	48	48	45	37
Do prostoru Lp dB(A)	47	19	26	36	40	39	38	36	29

CK315C	Tot	63 Hz	125 Hz	250 Hz	500 Hz	1 kHz	2 kHz	4 kHz	8 kHz
Od sání Lw dB(A)	76	52	61	65	64	67	70	71	67
Od výfuku Lw dB(A)	77	58	61	71	66	68	71	72	66
Do prostoru Lw dB(A)	55	25	44	46	47	46	49	48	37
Do prostoru Lp dB(A)	49	19	38	41	41	40	44	42	32

\* Hlukové údaje měřeny v nedefinovaném prostoru ve vzdálenosti 3 m, pro statický tlak 200 Pa

\*\* Lp: hladina akustického tlaku dB(A) ve vzdálenosti 3 m

\*\*\* Lw: hladina akustického výkonu dB(A)

**CHARAKTERISTIKA VENTILÁTORU  
CK100A**

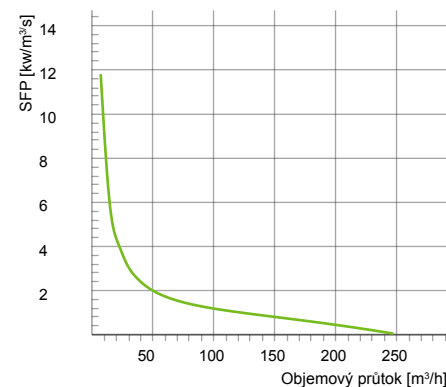
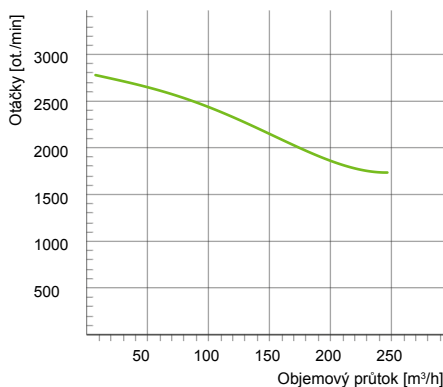
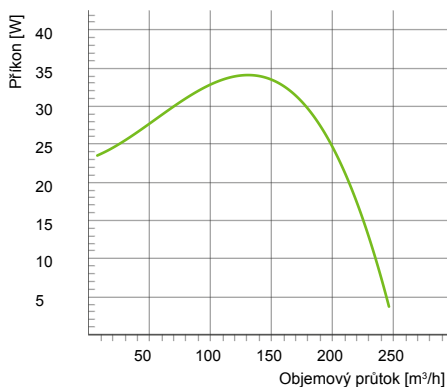
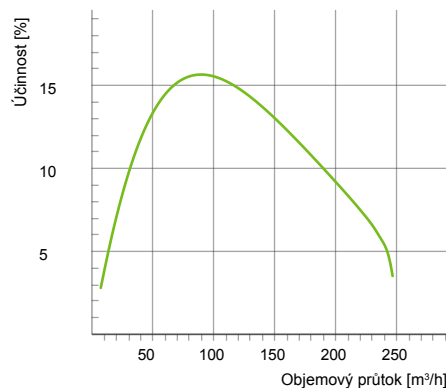
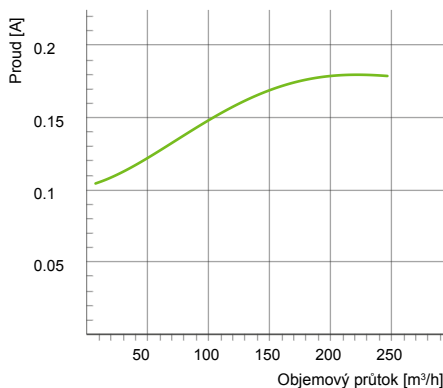
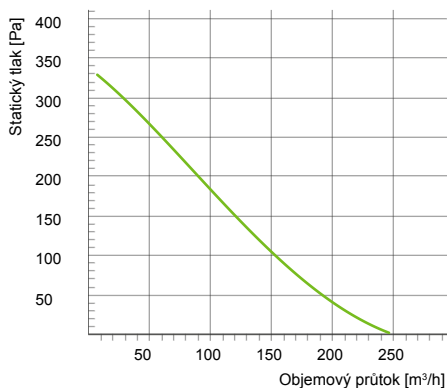

**CK100C**

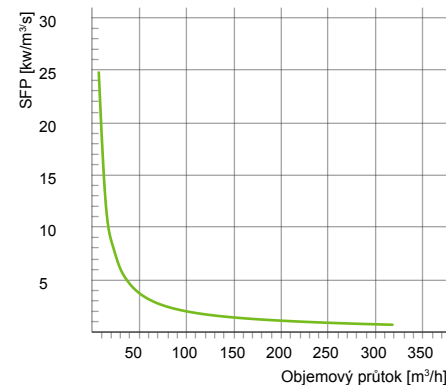
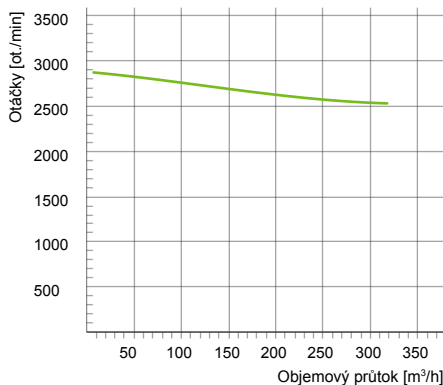
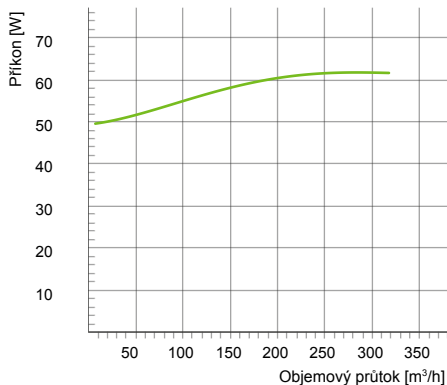
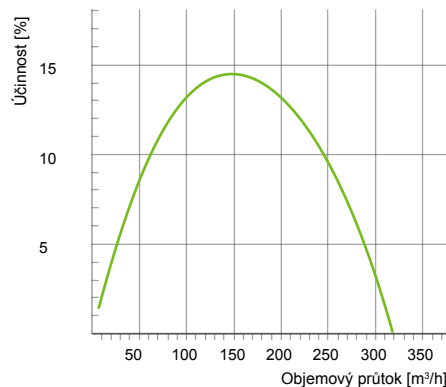
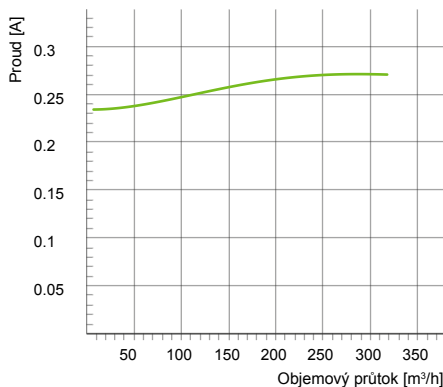
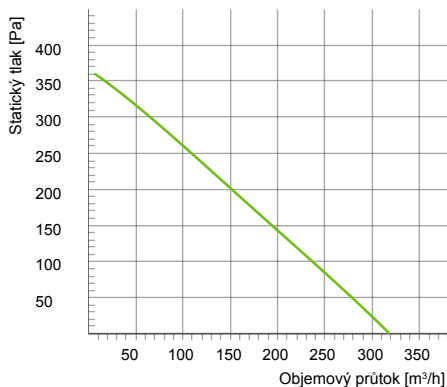

Typ	Napájení [V/Hz]	Hmotnost [kg]	Příkon [W]	Proud [A]	IP/GL	Otáčky [ot./min]	Teplota [°C]	Kondenzátor [µF]	Napojení [mm]	Max. průtok [m³/h]	Max. tlak [Pa]
CK100A	230/50	2,6	41	0,18	44/F	1730	60	3	100	248	338
CK100C	230/50	2,6	62	0,27	44/F	2530	60	2	100	317	366

**CK125A**

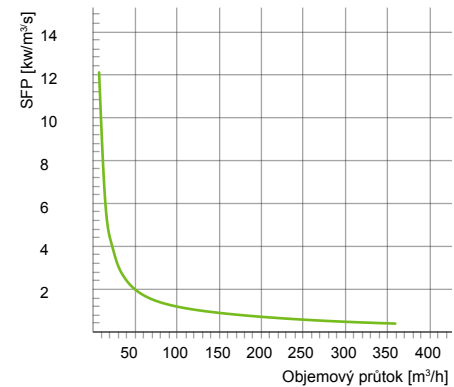
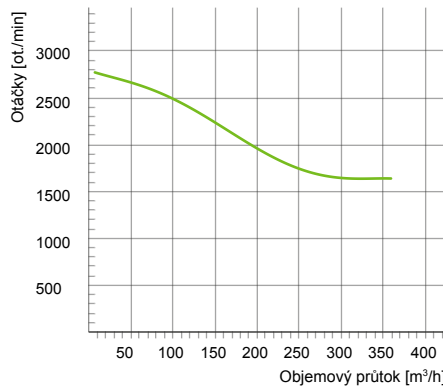
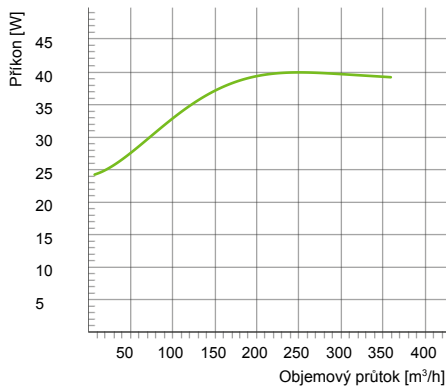
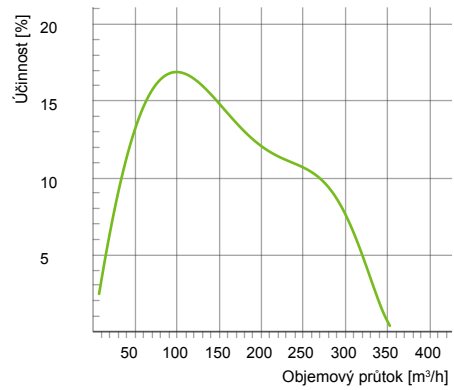
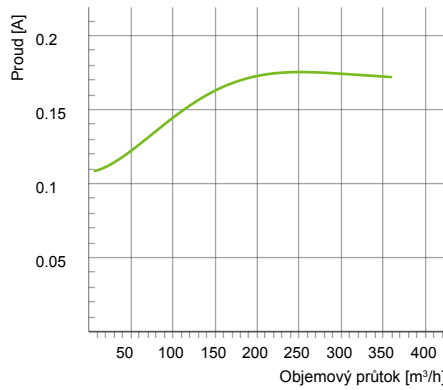
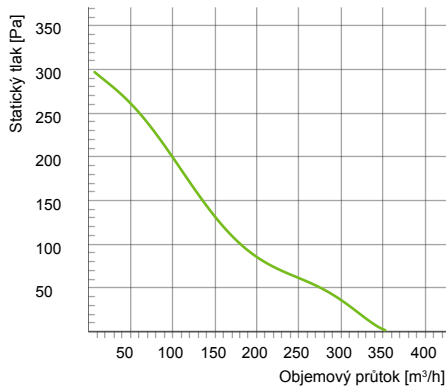

**CK125C**

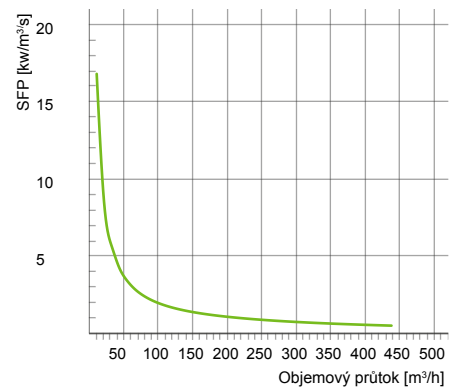
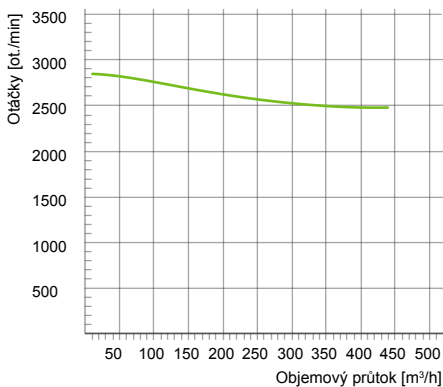
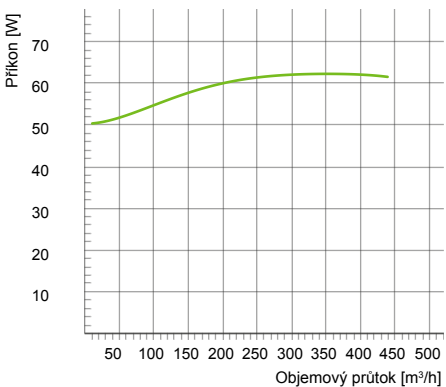
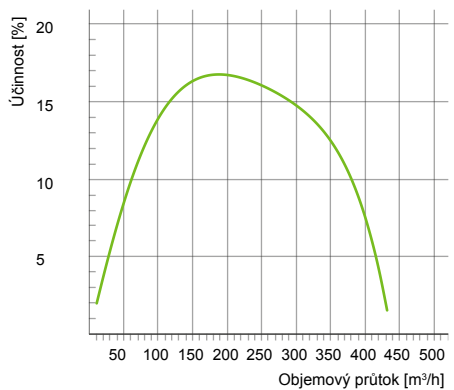
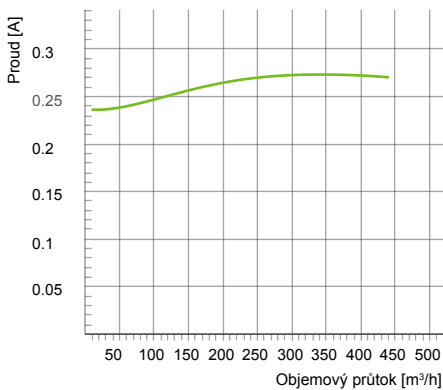
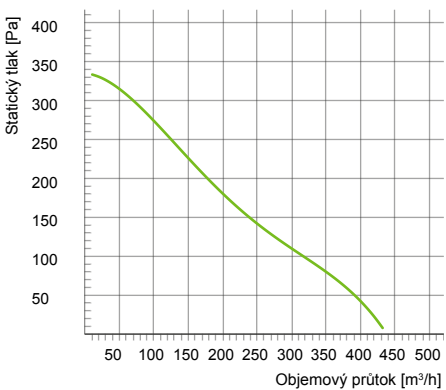

Typ	Napájení [V/Hz]	Hmotnost [kg]	Příkon [W]	Proud [A]	IP/CL	Otáčky [ot./min]	Teplota [°C]	Kondenzátor [μF]	Napojení [mm]	Max. průtok [m³/h]	Max. tlak [Pa]
CK125A	230/50	2,7	40	0,18	44/F	1640	60	3	125	360	303
CK125C	230/50	2,7	62	0,27	44/F	2480	70	2	125	439	335

**CK150B**

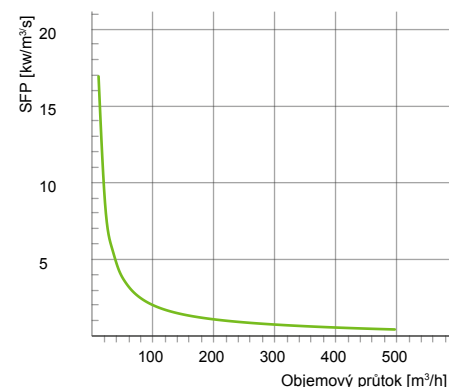
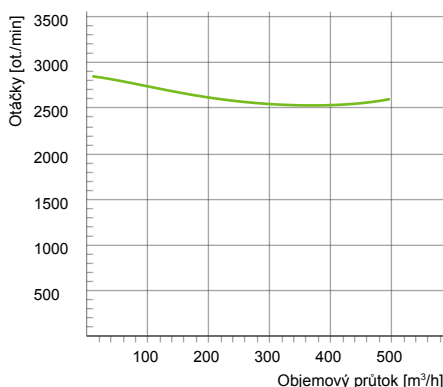
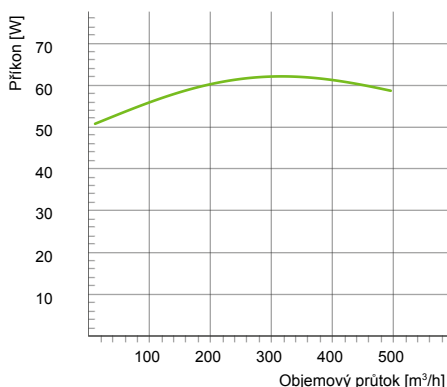
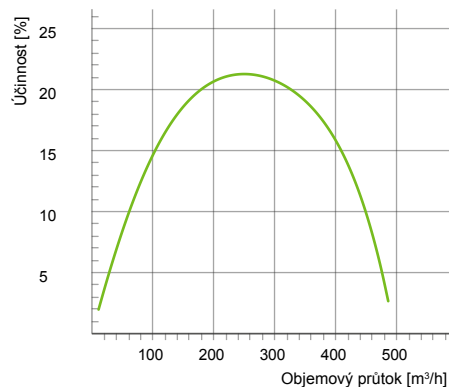
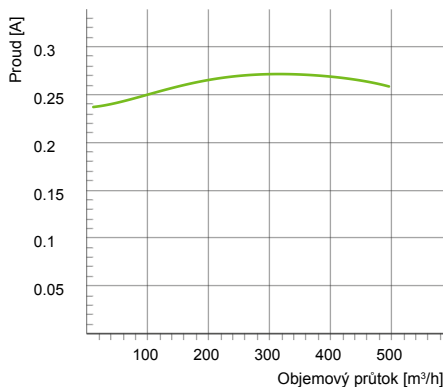
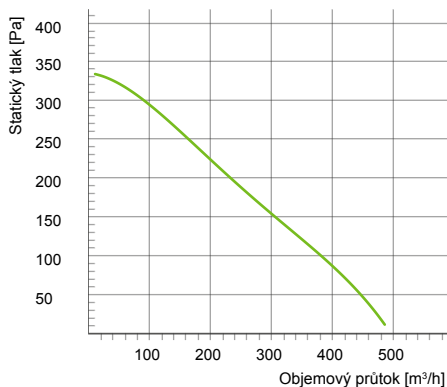

**CK150C**

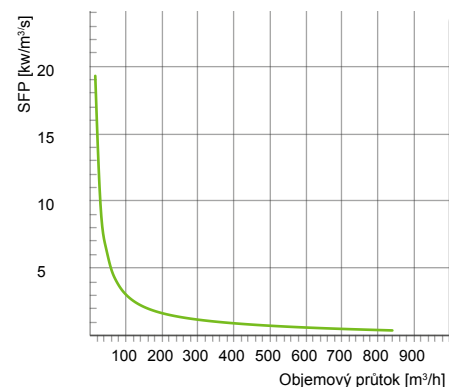
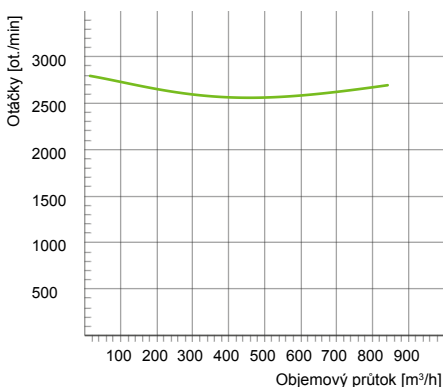
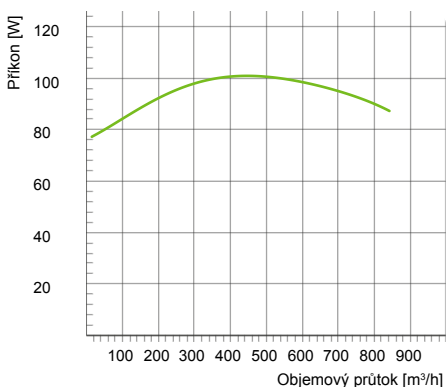
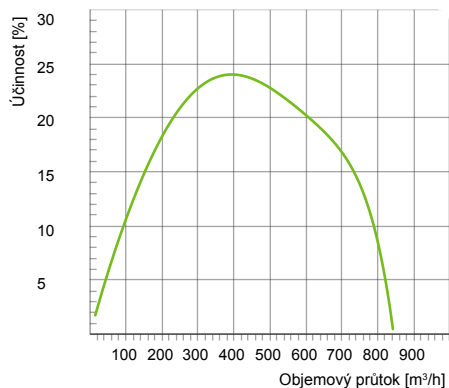
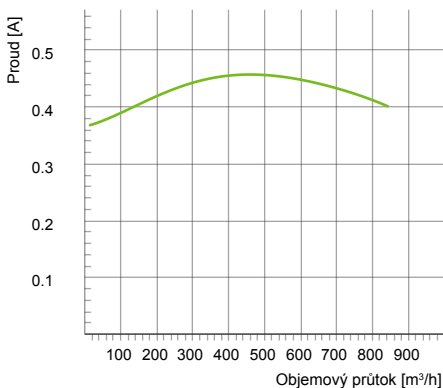
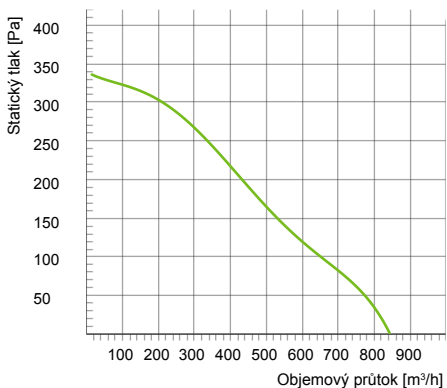

Typ	Napájení [V/Hz]	Hmotnost [kg]	Příkon [W]	Proud [A]	IP/CL	Otáčky [ot./min]	Teplota [°C]	Kondenzátor [μF]	Napojení [mm]	Max. průtok [m³/h]	Max. tlak [Pa]
CK150B	230/50	3	62	0,27	44/F	2540	60	2	150	497	335
CK150C	230/50	3	101	0,44	44/F	2480	65	3	150	842	339

**CK160B**

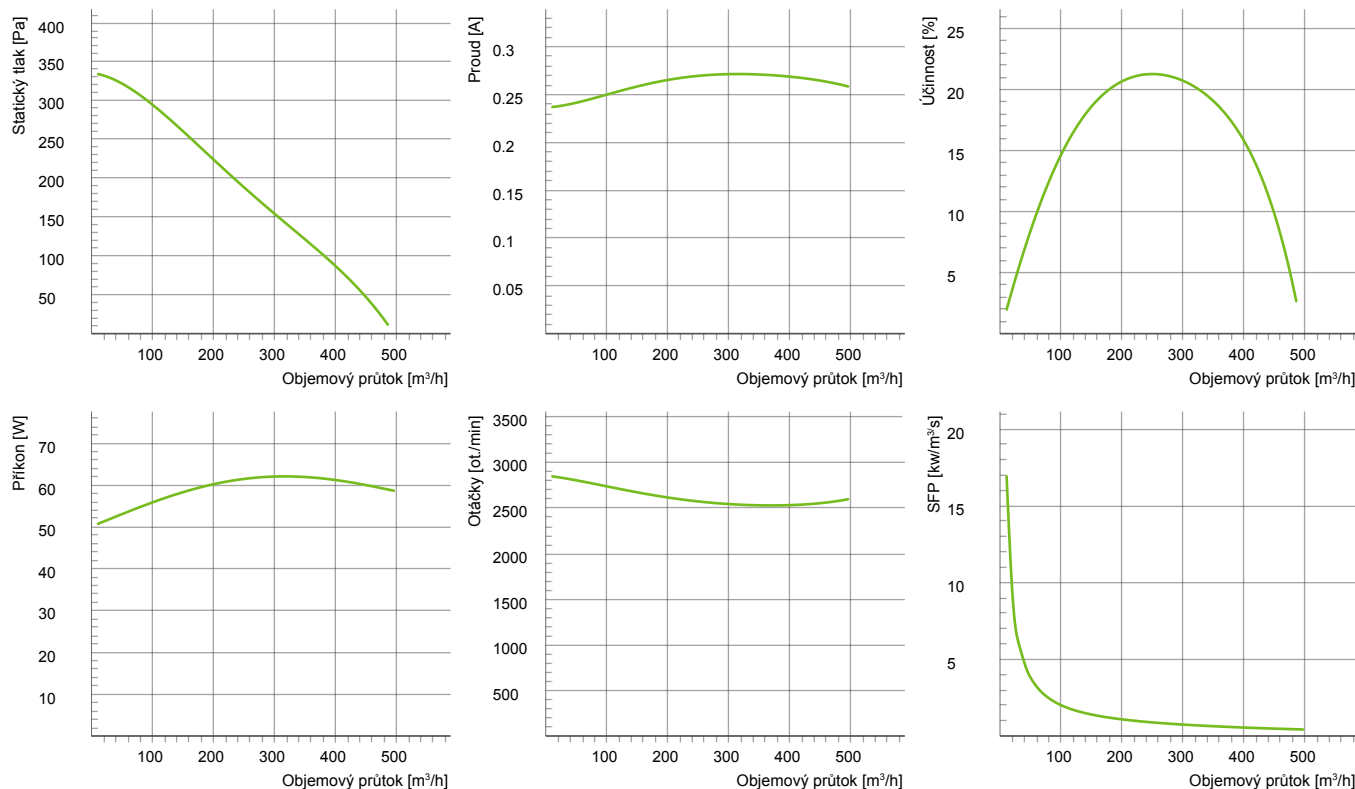

**CK160C**

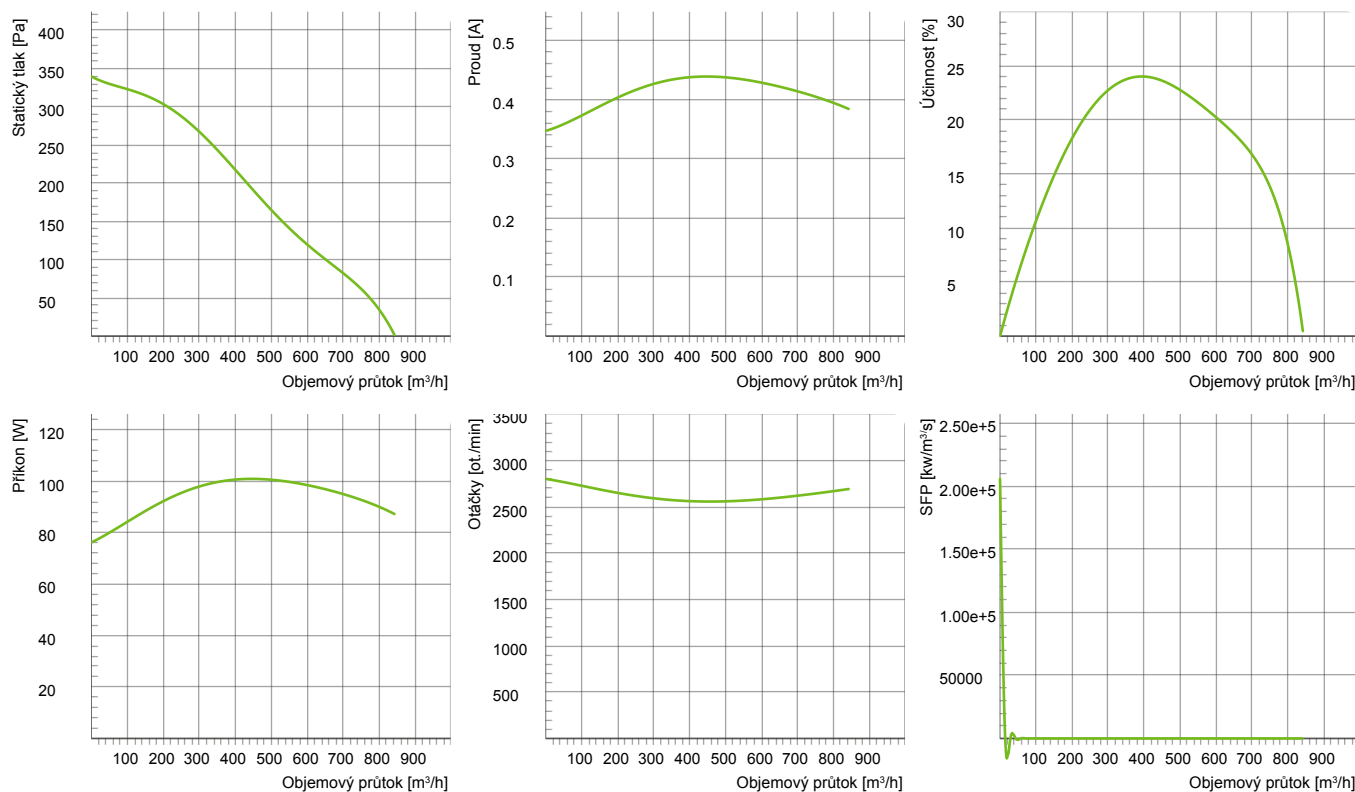

Typ	Napájení [V/Hz]	Hmotnost [kg]	Příkon [W]	Proud [A]	IP/CL	Otáčky [ot./min]	Teplota [°C]	Kondenzátor [µF]	Napojení [mm]	Max. průtok [m³/h]	Max. tlak [Pa]
CK160B	230/50	2,9	62	0,27	44/F	2540	60	2	160	497	335
CK160C	230/50	4	101	0,44	44/F	2480	65	3	160	842	339

**CK200A**

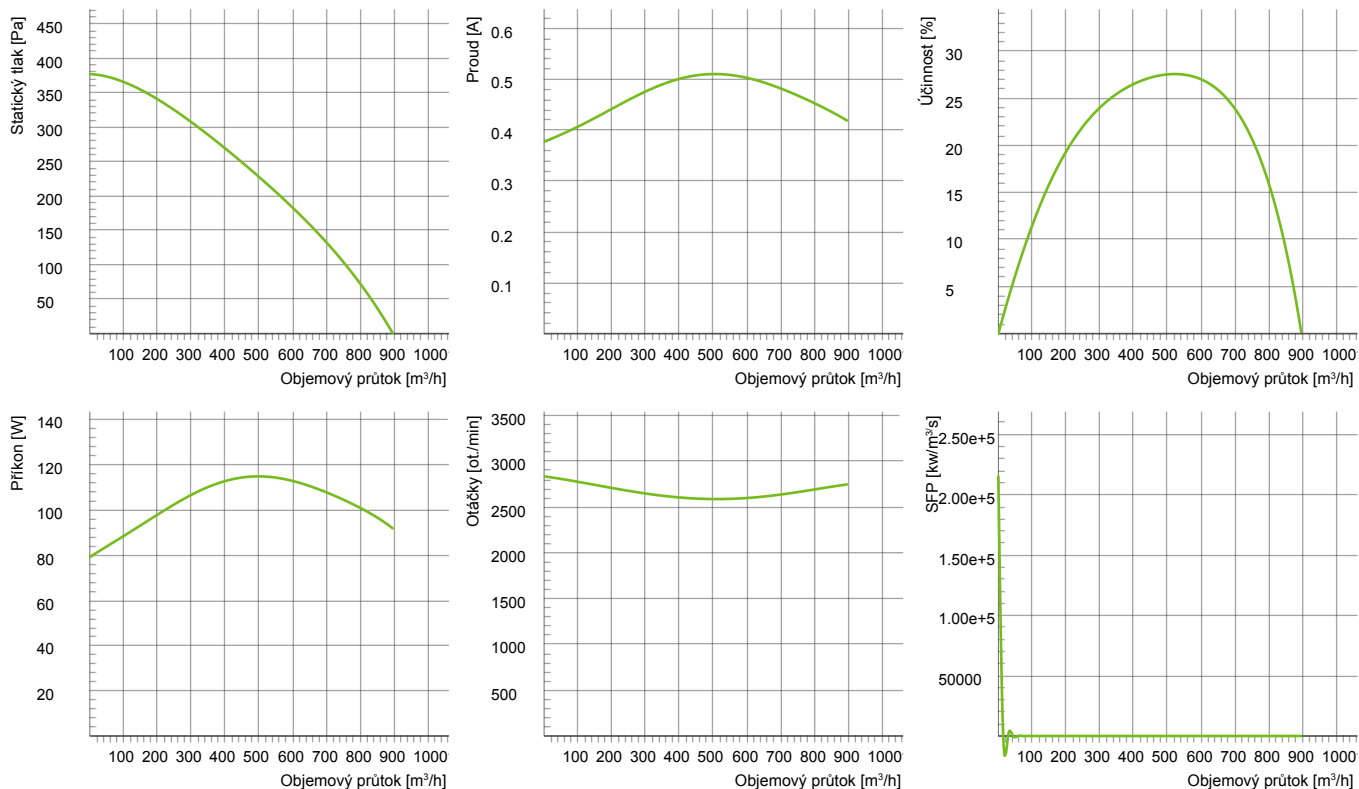

**CK200B**

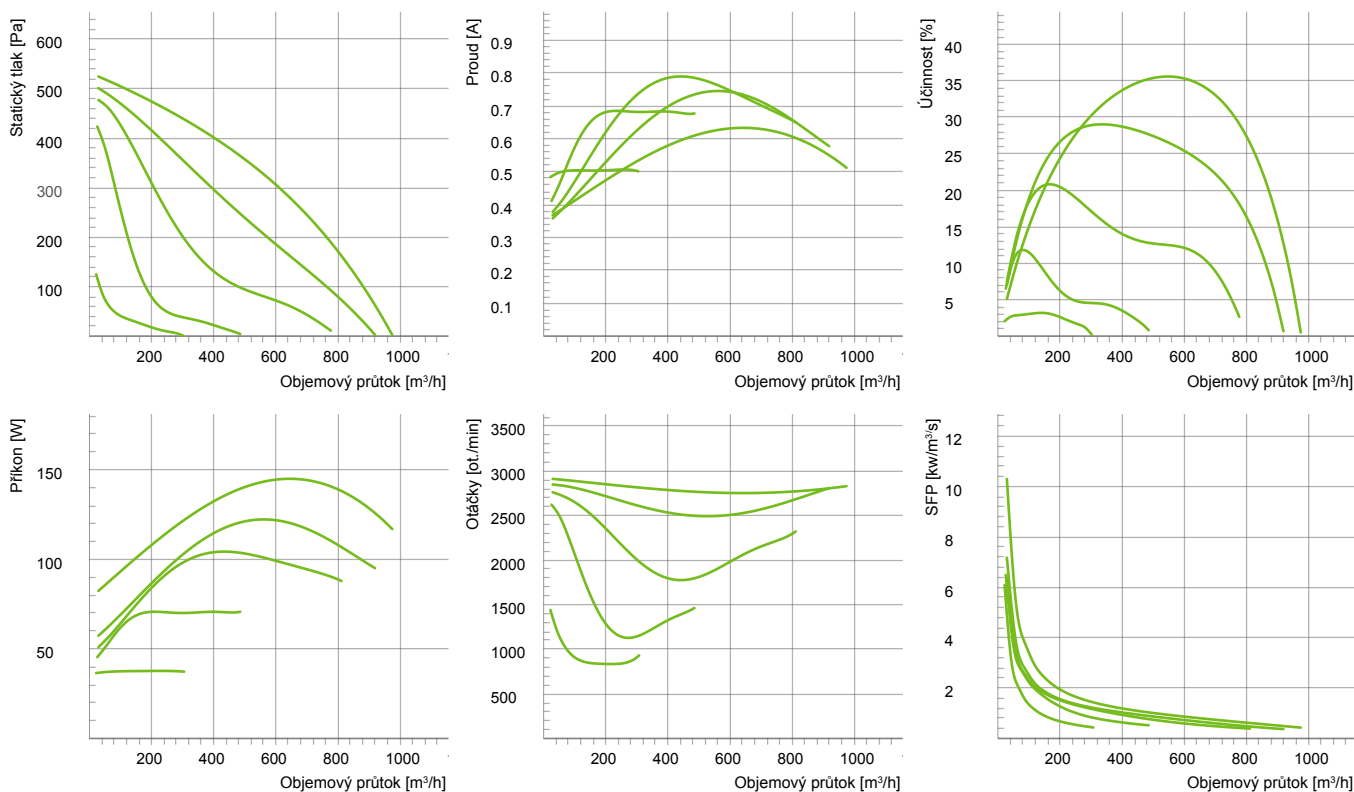

Typ	Napájení [V/Hz]	Hmotnost [kg]	Příkon [W]	Proud [A]	IP/CL	Otáčky [ot./min]	Teplota [°C]	Kondenzátor [µF]	Napojení [mm]	Max. průtok [m³/h]	Max. tlak [Pa]
CK200A	230/50	4,2	115	0,51	44/F	2580	60	4	200	896	377
CK200B	230/50	4,9	145	0,63	44/F	2750	60	5	200	976	530

**CK250A**

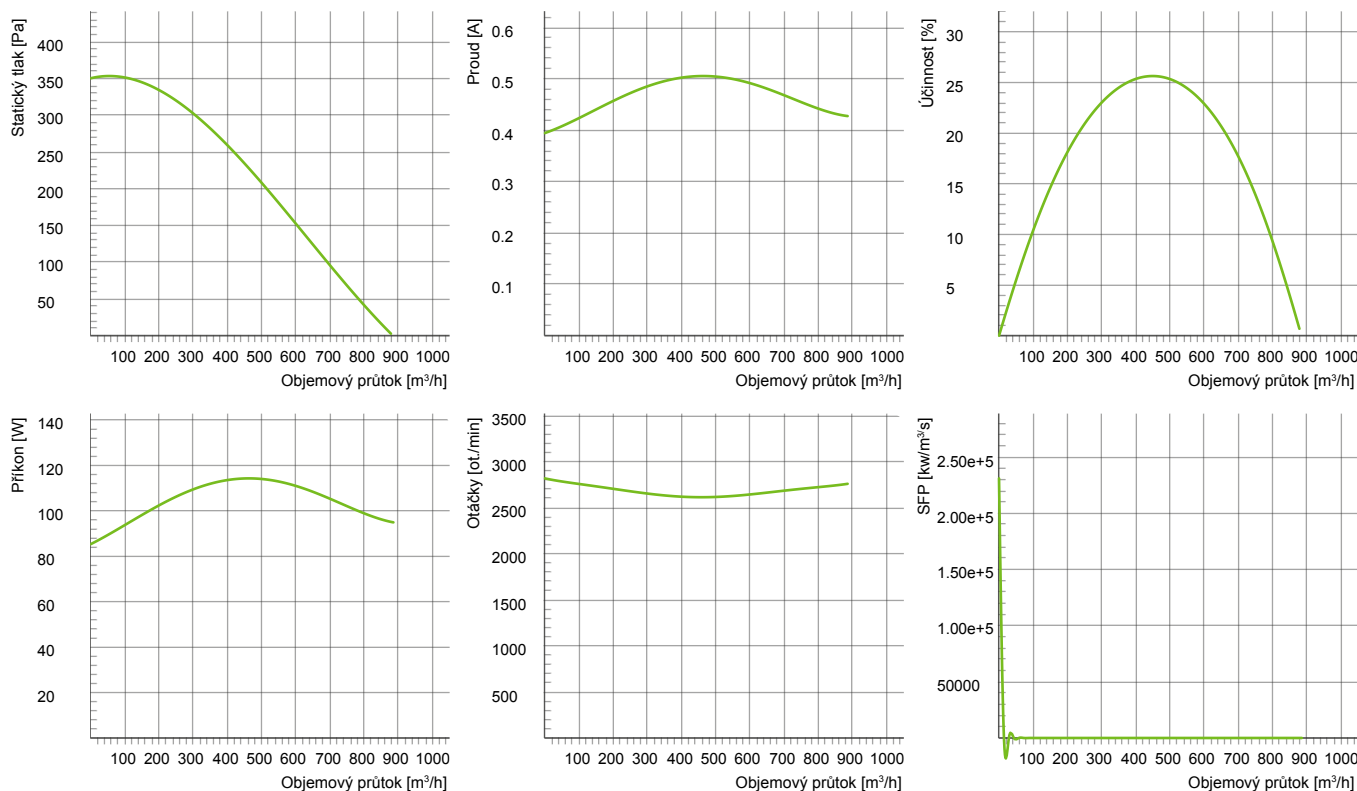

**CK250B**

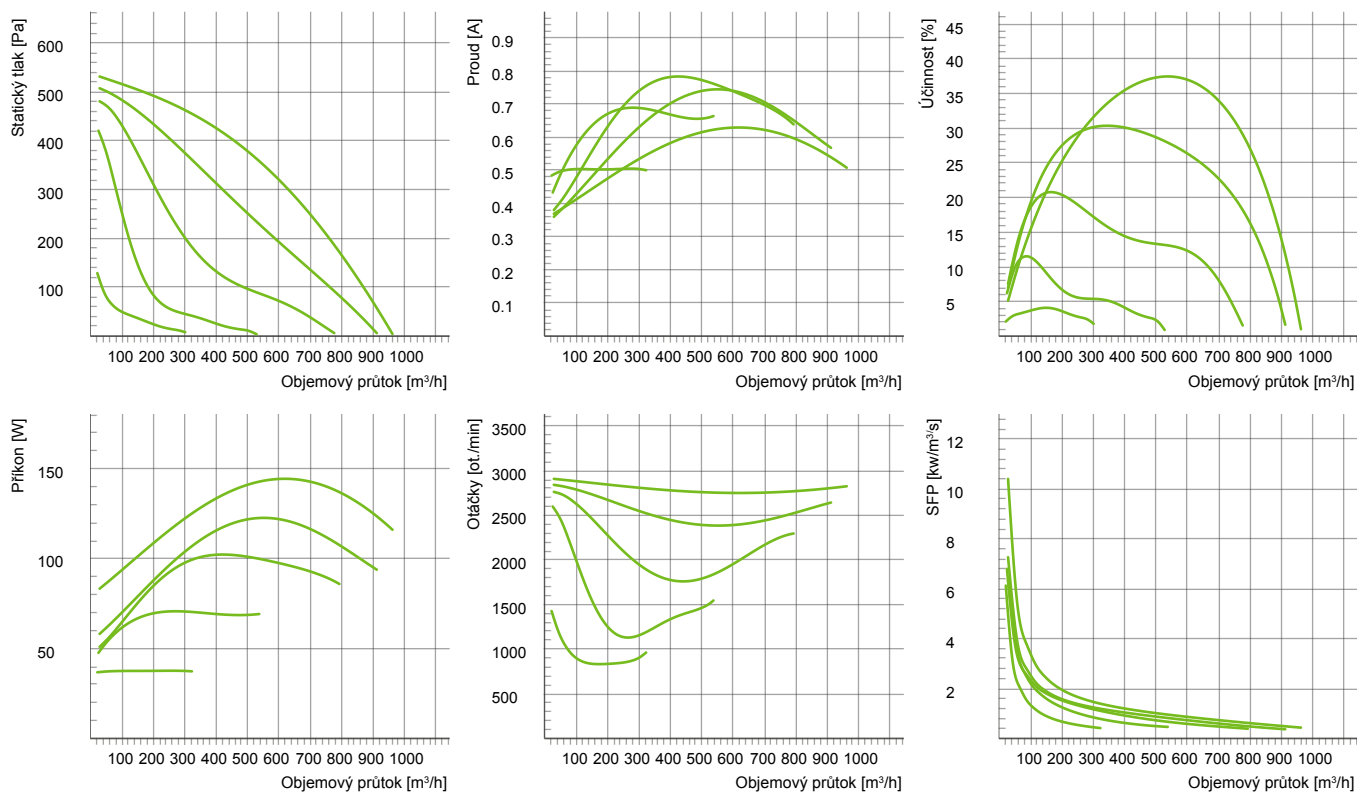

Typ	Napájení [V/Hz]	Hmotnost [kg]	Příkon [W]	Proud [A]	IP/CL	Otáčky [ot./min]	Teplota [°C]	Kondenzátor [µF]	Napojení [mm]	Max. průtok [m³/h]	Max. tlak [Pa]
CK250A	230/50	4,3	115	0,5	44/F	2580	60	4	250	886	354
CK250B	230/50	4,9	145	0,63	44/F	2750	60	5	250	961	533



**CK315B**

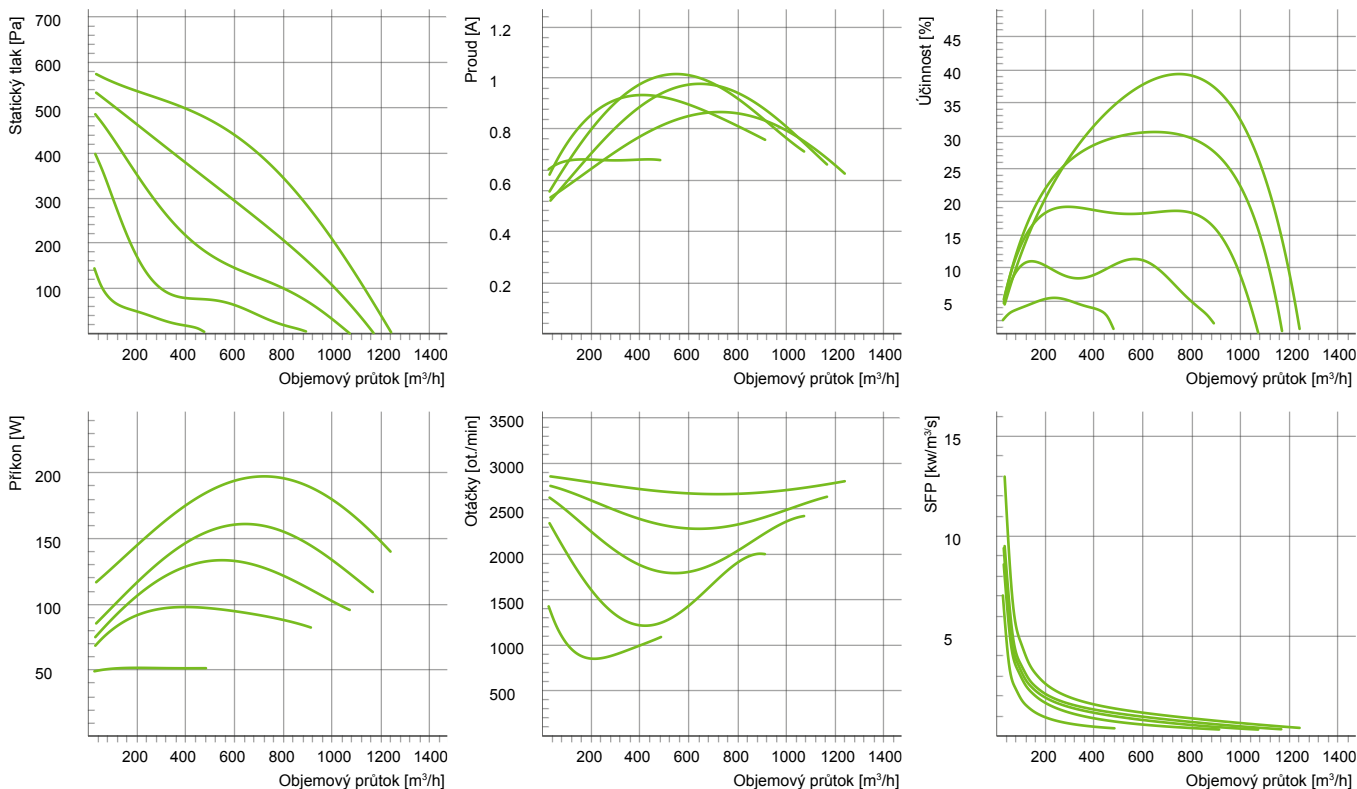

**CK315C**

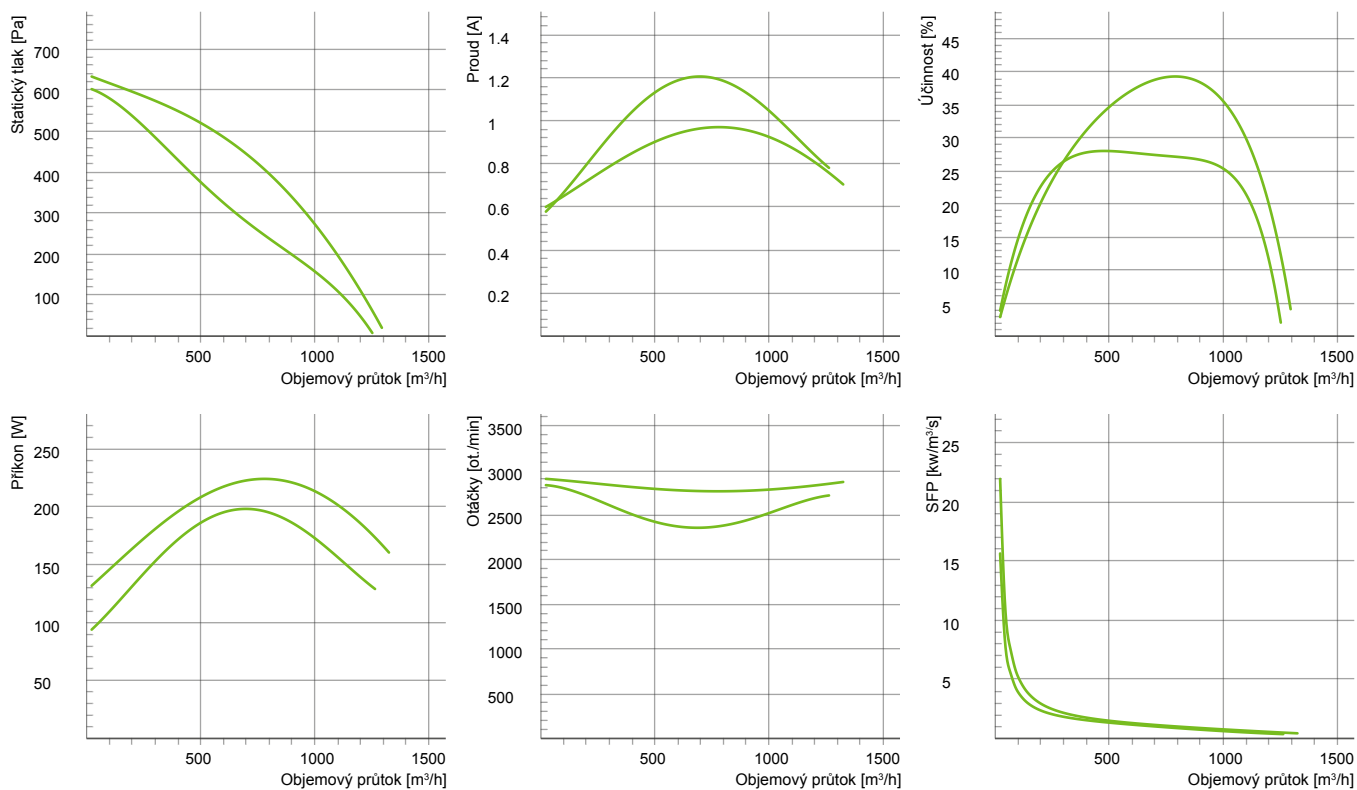

Typ	Napájení [V/Hz]	Hmotnost [kg]	Příkon [W]	Proud [A]	IP/CL	Otáčky [ot./min]	Teplota [°C]	Kondenzátor [µF]	Napojení [mm]	Max. průtok [m³/h]	Max. tlak [Pa]
CK315B	230/50	6,1	197	0,87	44/F	2660	70	6	315	1462	632
CK315C	230/50	5,9	224	1,2	44/F	2770	50	6	315	1325	632

**PŘÍSLUŠENSTVÍ REGULACE**

TYP	Regulace		
CK100A	VRS 0.5	VRDE 1.5	VRTE C
CK100C	VRS 0.5	VRDE 1.5	VRTE C
CK125A	VRS 0.5	VRDE 1.5	VRTE C
CK125C	VRS 0.5	VRDE 1.5	VRTE C
CK150B	VRS 0.5	VRDE 1.5	VRTE C
CK150C	VRS 0.5	VRDE 1.5	VRTE C
CK160B	VRS 0.5	VRDE 1.5	VRTE C
CK160C	VRS 1.0	VRDE 1.5	VRTE C
CK200A	VRS 1.0	VRDE 1.5	VRTE C
CK200B	VRS 1.0	VRDE 1.5	VRTE C
CK250A	VRS 1.0	VRDE 1.5	VRTE C
CK250B	VRS 1.0	VRDE 1.5	VRTE C
CK315C	VRS 2.0		

**VRS** – Tyristorový manuální regulátor otáček, minimální rychlost nastavena pomocí šroubu pod knoflíkem



**VRTE** – Manuální 5-stupňový transformátorový regulátor otáček pro AC motory s 0 polohou a polohami (1-2-3-4-5) pro 1f motory



**VRDE** – Manuální 5-stupňový transformátorový regulátor otáček pro AC motory s 0 polohou, přepínačem vysoké/nízké otáčky a polohami (1-2-3-4-5) pro 1f motory



**SCHÉMA ZAPOJENÍ**

CK100A, CK125A

CK100C, CK125C, CK150A, CK150C, CK160B, CK160C, CK200A, CK200B, CK250A, CK250B, CK315C

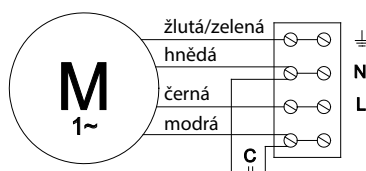
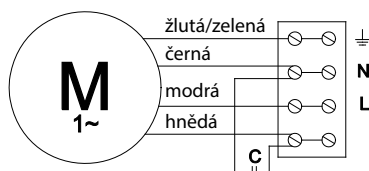

\* Uvedená schémata zapojení jsou pouze orientační, vždy má vyšší prioritu schéma zapojení uvedené na výrobku

**PŘÍSLUŠENSTVÍ**



**FLF-A**  
Kapsový filtrační box



**FLK-B**  
Deskový filtrační box

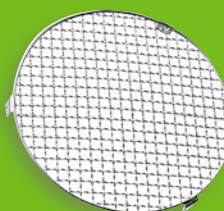

**BSV**  
Krycí mřížka



**MK**  
Pružná manžeta



**VK**  
Samočinná žaluzie



**YG**  
Kruhová hliníková krycí mřížka



**SPT-GLX**  
Kruhový tlumič hluku

**PŘÍKLAD ZNAČENÍ**

**CK100A**  
 — Výkonová řada  
 — Jmenovitý průměr v mm  
**CK** – Radiální potrubní ventilátor